

# Data Sheet

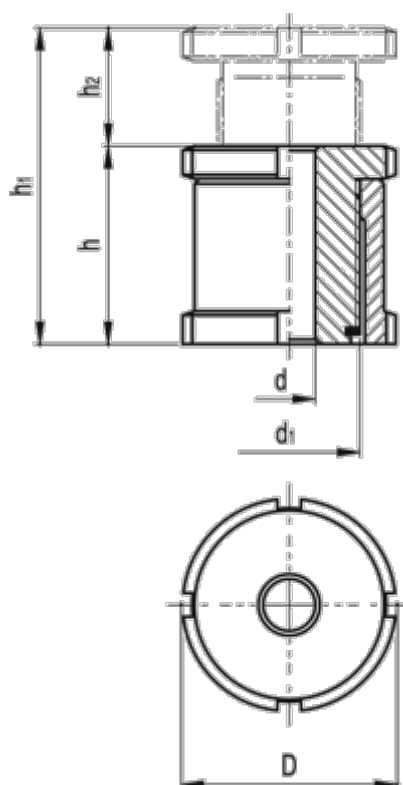

Article number: 20660214A  
Description: E+G Levelling set  
GN 350-45-17.5-A-ST

## Measures



C-spanner DIN 1810 = A45-50	
d	= 17.5
D	= 45
d1	= M30x1
For screw	= M16
h	= 42
h1	= 67
h2	= 25

Max static load (N)	= 120.0
Static preload (N)	= 45.5
Weight (g)	= 318